

INSTRUCTION MANUAL FOR BRAZED PLATE HEAT EXCHANGERS

TECHNICAL DATA AND APPROVALS

See the type label on the product.
For more details on approvals, please contact SWEP or see the appropriate product sheets on www.swep.net.

2 14 11 715 2 000001

Serial number

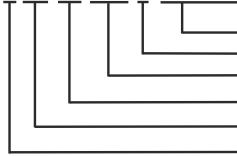

Number in series
Number of circuits
Product code
Month 11, i.e. November
Year 14, i.e. 2014
Production entity

WARRANTY

SWEP offers a 12-month warranty from the date of installation, but in no case longer than 15 months from the date of delivery. The warranty covers only manufacturing and material defects.

DISCLAIMER

The performance of SWEP BPHEs is based on their installation, maintenance, and operating conditions being in conformance with this manual. SWEP cannot assume any liability for BPHEs that do not meet these criteria.

The BPHE is not type-approved for fatigue loading.

GENERAL INFORMATION

The front plate of SWEP BPHEs is marked with an arrow, either on an adhesive sticker or embossed in the cover plate. This marker indicates the front of the BPHE and the location of the inner and outer circuits/channels. With the arrow pointing up, the left-hand side (ports F1, F3) is the inner circuit (for asymmetric units Narrow) and the right-hand side (ports F2, F4) is the outer circuit (for asymmetric units Wide).

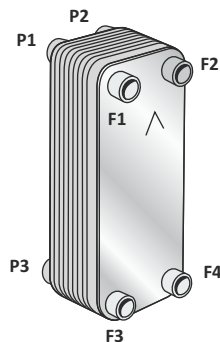

Ports F1/F2/F3/F4 are on the front of the BPHE. Ports P1/P2/P3/P4 are on the back. Note the order in which they appear.

FLOW CONFIGURATIONS

Fluids can pass through the BPHE in different ways. For parallel-flow BPHEs, there are two different flow configurations:

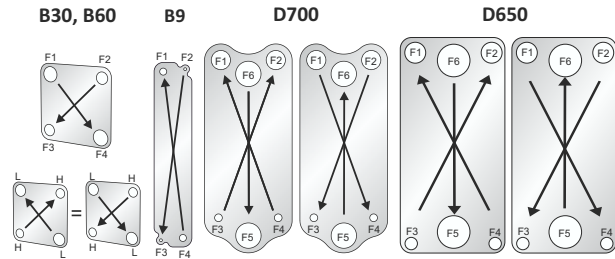
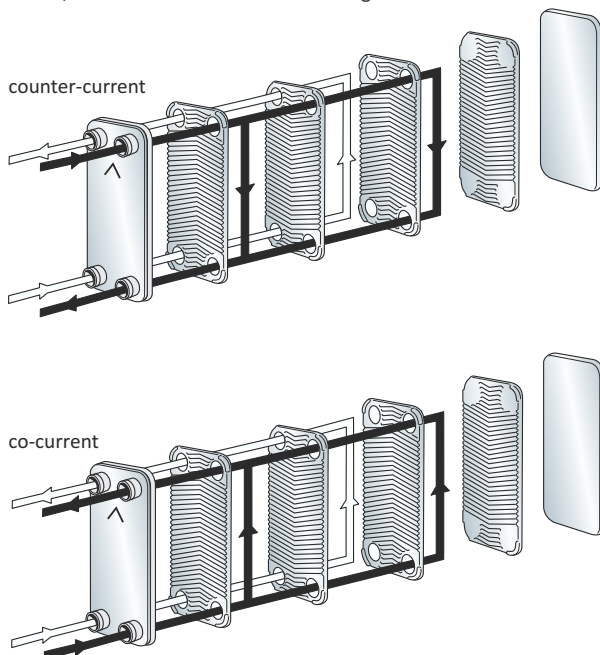

The B9, B30, B60, D650 and D700 have a cross-flow configuration, instead of the parallel flow normally found in BPHEs. In the B9, B30 and B60, ports F1-F4 are equivalent to the outer circuit, and ports F2-F3 to the inner circuit. For the D650 and D700, ports F5-F6 are the outer circuit and ports F1-F4 and F2-F3 are the inner circuits.

When using the B30 or B60 in single-phase applications, you achieve the same thermal performance regardless of the inlet/outlet arrangement due to its quadratic shape and cross-flow arrangement. However, the choice of fluid stream on the H and L sides depends on the thermal and hydraulic performance requirements. When using the B30 or B60 as a condenser, it is important that the refrigerant enters through port F2 and leaves through F3.

LIFTING INSTRUCTIONS FOR LARGER BPHEs

- Lifting in horizontal position
- Lifting from horizontal to vertical position
- Lifting in vertical position

WARNING.

Risk of personal injury. Maintain a safety separation of 3 m (10 ft) when lifting.

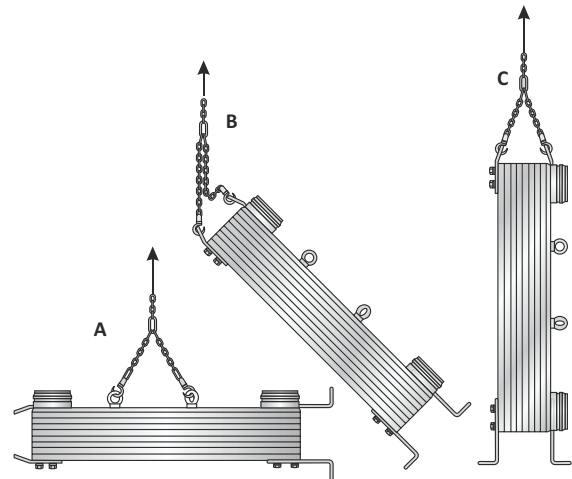

MOUNTING

Never expose the BPHE to excessive pulsations (i.e. cyclic pressure or temperature changes). It is also important that no vibrations are transferred to the BPHE. If there is a risk of this, install vibration absorbers. For large connection diameters, we advise you to use an expanding device in the pipeline. It is also suggested that a buffer (e.g. a rubber mounting strip) be installed between the BPHE and the mounting clamp.

Mounting direction

In single-phase applications (e.g. water-to-water or water-to-oil), the mounting orientation has little or no effect on the performance of the BPHE. However, in two-phase applications the BPHE's orientation becomes very important. In two-phase applications, SWEP BPHEs should be mounted vertically, with the front plate pointing upwards.

Mounting suggestions

Mounting suggestions are shown below. Support legs, brackets, and insulation are available as options.

It is advised to use a lubricant when mounting nut on the stud bolt. It prevents from tearing off studbolt.

- A. Supported from the bottom
- B. Sheet metal bracket (x = rubber insert)
- C. Crossbar and bolts (x = rubber insert)
- D. With mounting stud bolts on the front or back cover plate
- E. Support legs are available for some larger BPHEs
- F. Insulation for refrigerant applications
- G. Insulation for heating applications

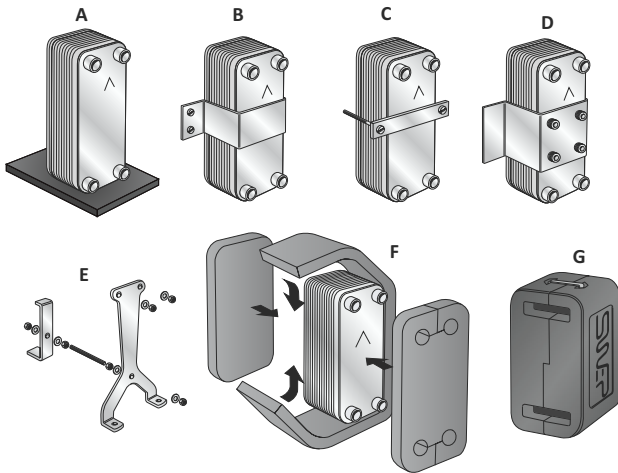

CONNECTIONS

All connections are brazed to the BPHE in the general vacuum-brazing cycle, a process that gives a very strong seal between the connection and the cover plate. However, note the following warning.

WARNING

Risk of damaging the connection

Do not join the counterpart with such force that the connection is damaged.



Depending on the application, many options are available for the types and locations of the connections (e.g. Compac flanges, SAE flanges, Rotalock, Victualic, threaded, and welding). It is important to select the correct international or local standard of connection, because they are not always compatible.

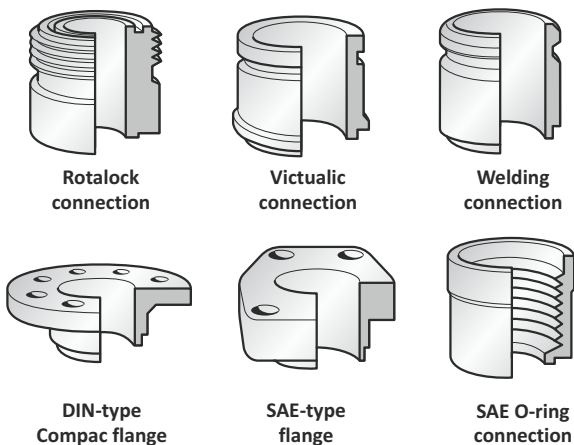

Some connections are equipped with a special plastic cap to protect the connection's threads and sealing surface (X) and to prevent dirt and dust from entering the BPHE. This plastic cap should be removed with care to avoid

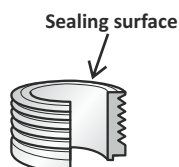

damaging the thread, sealing surface, or any other part of the connection. Some connections have an external heel whose purpose is to facilitate pressure and leakage testing of the BPHE in production.

Soldering Connections

The soldering connections (sweat connections) are in principle designed for pipes with dimensions in mm or inches. The measurements correspond to the internal diameter of the connections. Some of SWEP's soldering connections are universal, i.e. fit both mm- and inch-denominated pipes. These are denominated xxU. For example, the 28U fits both 1 1/8" and 28.75 mm pipes.

All BPHEs are vacuum-brazed with either a pure copper or a stainless steel filler. Soldering flux is used to remove oxides from the metal surface. The flux's properties make it potentially very aggressive. Consequently, it is very important to use the correct amount of flux, because too much might lead to severe corrosion. No flux must be allowed to enter the BPHE.

Soldering procedure

Degrease and polish the surfaces. Apply flux. Insert the copper tube into the connection, hold it in place and braze with min. 45% silver solder at max. 450 °C (840 °F) when soft soldering and 450-800 °C (840-1470 °F) when hard soldering. Do not direct the flame at the BPHE. Use a wet rag to avoid overheating the BPHE. Protect the BPHE's interior (refrigerant side) from oxidation with N2 gas.

WARNING

Excessive heating can lead to fusion of the copper and thus to the destruction of the BPHE.



If additional welding is necessary, please consider that BPHEs and their parts have been exposed to the extensive heat treatment during the manufacturing process, which may lead into changed welding process parameters.

When SWEP supplies an adapter or flange that is soldered to the BPHE by the customer, SWEP does not assume any responsibility for incorrect soldering nor for any accidents that may occur during the process.

Welding connections

Picture A. Welding is only recommended for specially designed welding connections. All SWEP's welding connections have a 30° chamfer on the top of the connection. Do not weld on pipes on other types of connections. The measurement in mm corresponds to the external diameter of the connection.

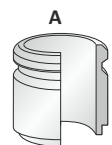

Welding procedure

Protect the BPHE from excessive heating by:

- a) using a wet cloth around the connection
- b) making a chamfer on the joining tube and the connection edges as shown (Picture B)

Use TIG or MIG/MAG welding.

When using electrical welding circuits, connect the ground terminal to the joining tube, not to the back of the plate package. A small flow of nitrogen through the BPHE will reduce internal oxidation.

Make sure there are no traces of copper adjacent to the prepared joint. If the joint is prepared by grinding, take appropriate measures to prevent copper from being ground into the stainless surface.

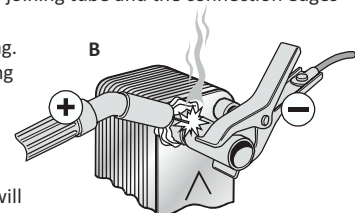

Allowable connection loads for pipe at installation

The maximum recommended connection loads given in Table A1 are valid during installation. Values for Deep Drawn (DD) connections see in Table A2.

Connection load during operation

The piping are to be well supported so that no loads are transferred to the BPHE during operation.

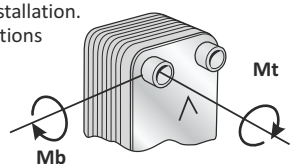

A1

Pipe size	Shear force, Fs*		Tension force, Ft		Bending moment, Mb		Torque, Mt	
	(kN)	(kp)	(kN)	(kp)	(Nm)	(kpm)	(Nm)	(kpm)
½"	3.5	357	2.5	255	20	2	35	3.5
¾"	12	1224	2.5	255	20	2	115	11.5
1"	11.2	1142	4	408	45	4.5	155	16
1 ¼"	14.5	1479	6.5	663	87.5	9	265	27
1 ½"	16.5	1683	9.5	969	155	16	350	35.5
2"	21.5	2193	13.5	1377	255	26	600	61
2 ½"	44.5	4538	18	1836	390	40	1450	148
3"	55.5	5660	18.4	1876	575	59	2460	251
4"	73	7444	41	4181	1350	138.5	4050	413.5
6"	169	17233	63	6424	2550	260	13350	1361

A2

Pipe size	DD conn. size	Shear force, Fs*		Tension force, Ft		Bending moment, Mb		Torque, Mt	
		(kN)	(kp)	(kN)	(kp)	(Nm)	(kpm)	(Nm)	(kpm)
3/8"	9.65	3.5	357	2.5	255	10	1	35	3.5
1/2"	12.8	3.5	357	2.5	255	10	1	35	3.5
5/8"	16	3.5	357	2.5	255	10	1	35	3.5

*Shear force (Fs) is calculated at the base of the connection.

Allowable loads for stud bolt assembly conditions

Mounting stud bolts for BPHEs are available as an option. These stud bolts are welded to the BPHE. The maximum allowable loads on the stud bolts during assembly are stated in Table B.

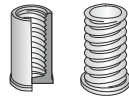

B

Stud bolt	Stress area As (mm²)	Tension force Ft (N)	Torque Mt (Nm)
M6	20.1	1400	3
M8	36.6	2600	8
M12	84.3	6000	27

UNC Stud bolt	Stress area As (in²)	Tension force Ft (lbf)	Torque Mt (lbf·in)
1/4"	0.032	315	27
5/16"	0.053	585	71
1/2"	0.144	1349	239

INSTALLING BPHEs IN DIFFERENT APPLICATIONS

Single-phase applications

Normally, the circuit with the highest temperature and/or pressure should be connected on the left-hand side of the BPHE when the arrow is pointing upwards. For example, in a typical water-to-water application, the two fluids are connected in a counter-current flow, i.e. the hot water inlet is connection F1, the outlet F3, the cold water inlet F4, and the outlet F2. This is because the right-hand side of the BPHE contains one channel more than the left-hand side, and the hot medium is thus surrounded by the cold medium to prevent heat loss.

Two-phase applications

It is very important that in all refrigerant applications every refrigerant channel has a water/brine channel on both sides. Normally, the refrigerant side must be connected to the left-hand side and the water/brine circuit to the right-hand side of the BPHE. If the refrigerant is connected incorrectly to the first and last channels, instead of water/brine, the evaporation temperature will drop, with the risk of freezing and very poor performance. SWEP BPHEs used as condensers or evaporators should always be fitted with adequate connections on the refrigerant side.

Condensers (Picture A)

The refrigerant (gas/steam) should be connected to the upper left connection, F1, and the condensate to the lower left connection, F3. The water/brine circuit inlet should be connected to the lower right connection, F4, and the outlet to the upper right connection, F2.

BPHEs with UL approval for use with CO₂ according to UL files section II or VI. When used with CO₂, the system should include a pressure relief valve on each side of the BPHE. The pressure relief valve must open if the system pressure reaches 0.9 × design pressure.

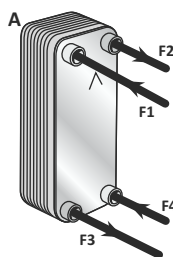

Evaporators (Picture B)

The refrigerant liquid should be connected to the lower left connection (F3) and the refrigerant gas outlet to the upper left connection (F1). The water/brine circuit inlet should be connected to the upper right connection (F2), and the outlet to the lower right connection (F4).

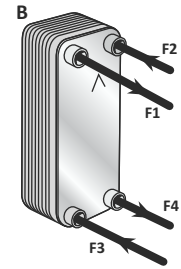

Expansion Valves

The expansion valve should be placed within a certain distance to the evaporator inlet without bends, expansions or reductions in between. The recommended distance between expansion valve and evaporator inlet is 150-300 mm, or with the ratio of the pipe length to the pipe's inner diameter equal to 10-30. It is also important to keep the piping horizontally. The pipe diameter between the expansion valve and the BPHE is important for the thermal performance.

The pipe should normally have the same diameter as the connection and in order to achieve the optimal flow regime the correct diameter can be selected with SWEP's software tool SSP. Another option is to use a coned connection if the pipe is smaller than the connection. The inlet connection selected should never be larger than the inlet port diameter of the F3 port, because this increases the risk of phase separation. Due to the distribution device, the inlet port size (F3) is smaller in an evaporator than in a B-model.

If an expansion valve bulb is used the bulb should be mounted about 200 mm from the vaporized refrigerant outlet connection. For evaporators, the total pressure drop is the pressure drop in the internal distribution system plus that in the expansion valve. Selecting the next larger size valve will normally give satisfactory performance

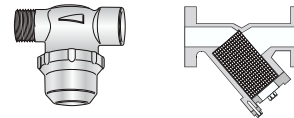

Freezing Protection

- a) Use a filter < 1 mm, 16 mesh
- b) Use an antifreeze when the evaporation temperature is close to the liquid-side freezing point
- c) Use a freeze protection thermostat and flow switch to guarantee a constant water flow before, during, and after compressor operation
- d) Avoid using the "pump-down" function
- e) When starting up a system, pause briefly before starting the condenser (or have a reduced flow through it)
- f) If any of the media contain particles larger than 1 mm (0.04 inch), a strainer should be installed before the BPHE

CLEANING OF THE BPHEs

The normally very high degree of turbulence in BPHEs produces a self-cleaning effect in the channels. However, in some applications the fouling tendency can be very high (e.g. when using extremely hard water at high temperatures). In such cases, it is always possible to clean the BPHE by circulating a cleaning liquid (CIP – Cleaning In Place). Use a tank with weak acid, 5% phosphoric acid, or if the BPHE is cleaned frequently, 5% oxalic acid. Pump the cleaning liquid through the BPHE.

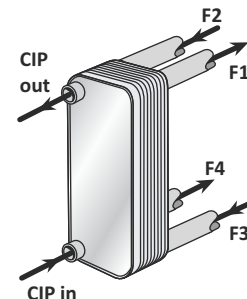

For demanding installations, we recommend factory-installed CIP connections/valves for easy maintenance. When cleaning, pump the cleaning solution through the BPHE from the lower connection to vent air. For optimal cleaning, the flow rate should be at least 1.5 times the normal flow rate, preferably in a back-flush mode. Reverse the flow direction every 30 min if possible. After cleaning, remember to rinse the BPHE carefully with clean water. A solution of 1-2% sodium hydroxide (NaOH) or sodium bicarbonate (NaHCO₃) before the final rinse ensures that all acid is neutralized. Clean at regular intervals. For further information about cleaning BPHEs, please consult SWEP's CIP information or your local SWEP company.

Bleeding the BPHE

A bleeding valve must be assembled on the warm side of the BPHE, where the gas is least soluble in water. Make sure it is positioned high relative to the BPHE. Depending on the need, the frequency of bleeding required will vary.

STORAGE

BPHEs must be stored dry. In long-term storage (longer than two weeks), the temperature should be between 1 °C and 50 °C.

APPEARANCE

Extensive copper stains may occur on the BPHE's surface following brazing. This discoloration is not corrosion and does not affect the BPHE's performance or way of use.

DISPOSAL

Please note; after end of life, the BPHE should be disposed in accordance with local Environmental legislation regulations.

For further information, please consult SWEP's technical information or your local SWEP company.



www.swep.net